

WELCOME

CS60 DECT™ Wireless Headset System User Guide

Thank you for selecting the CS60 DECT™ Wireless Headset System from Plantronics.

The CS60 offers wireless, hands-free headset convenience and long range workspace mobility.

This user guide provides instructions on the installation and usage of your system.

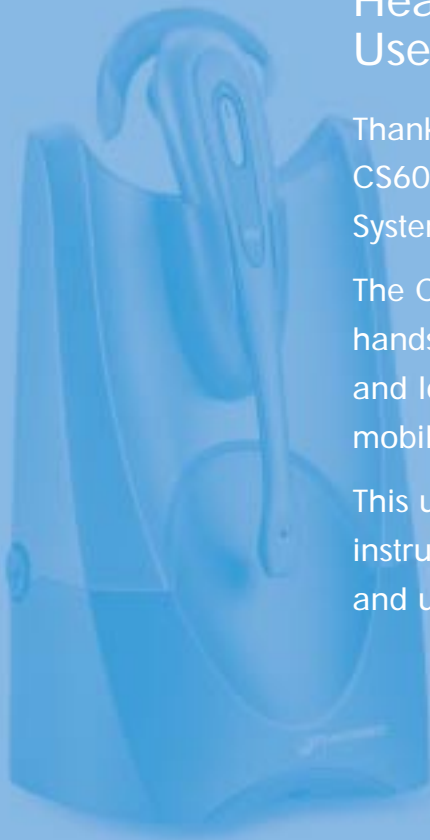

www.plantronics.com

DIAGRAM KEY

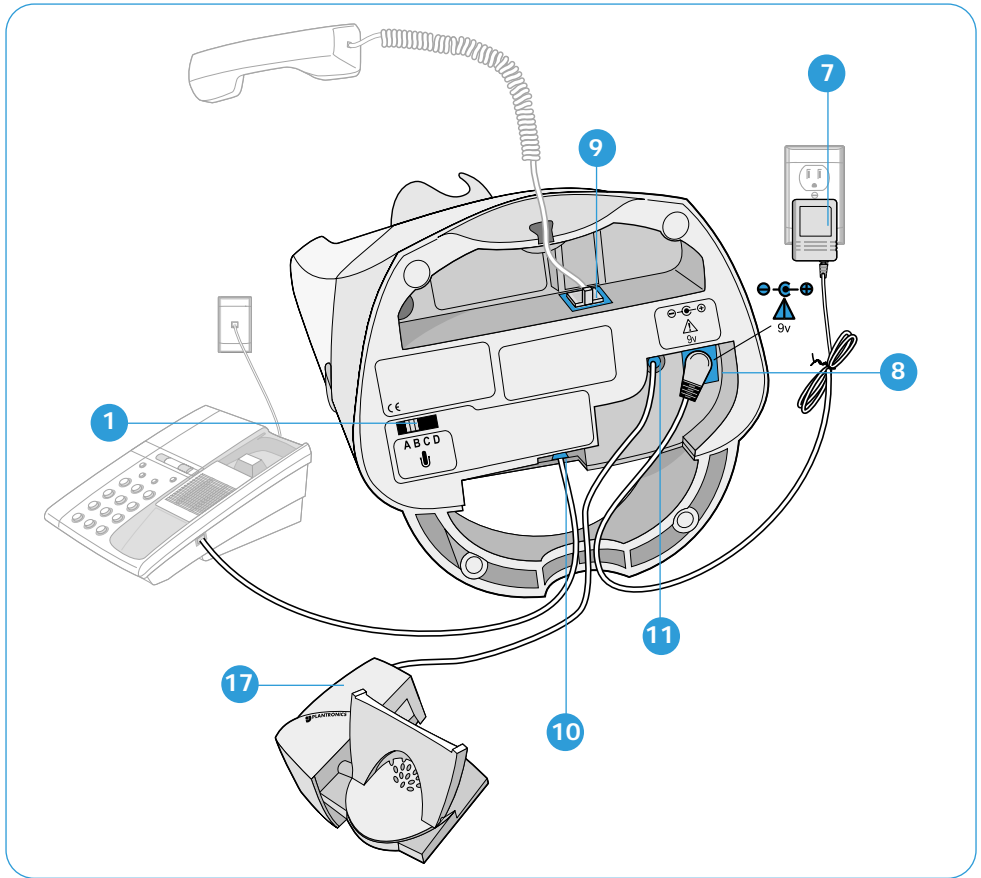

HEADSET

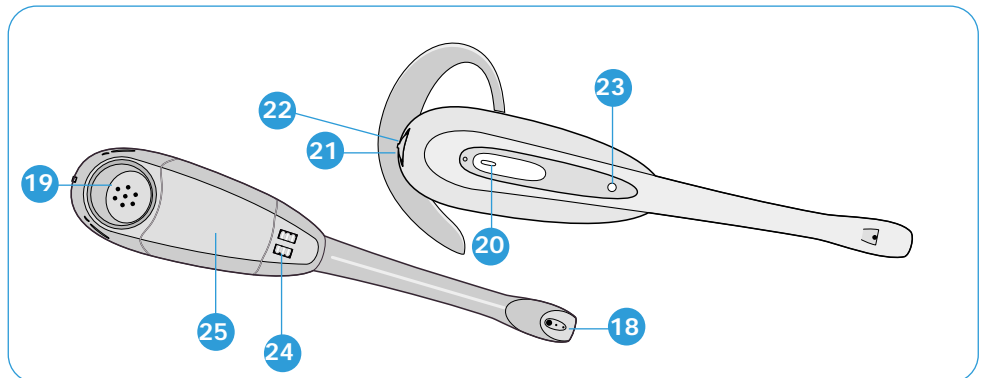

BASE UNIT

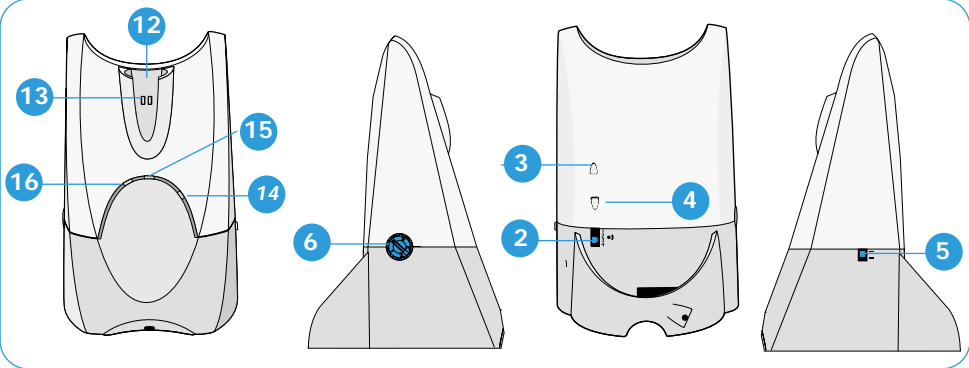

INSTALLING A REPLACEMENT BATTERY

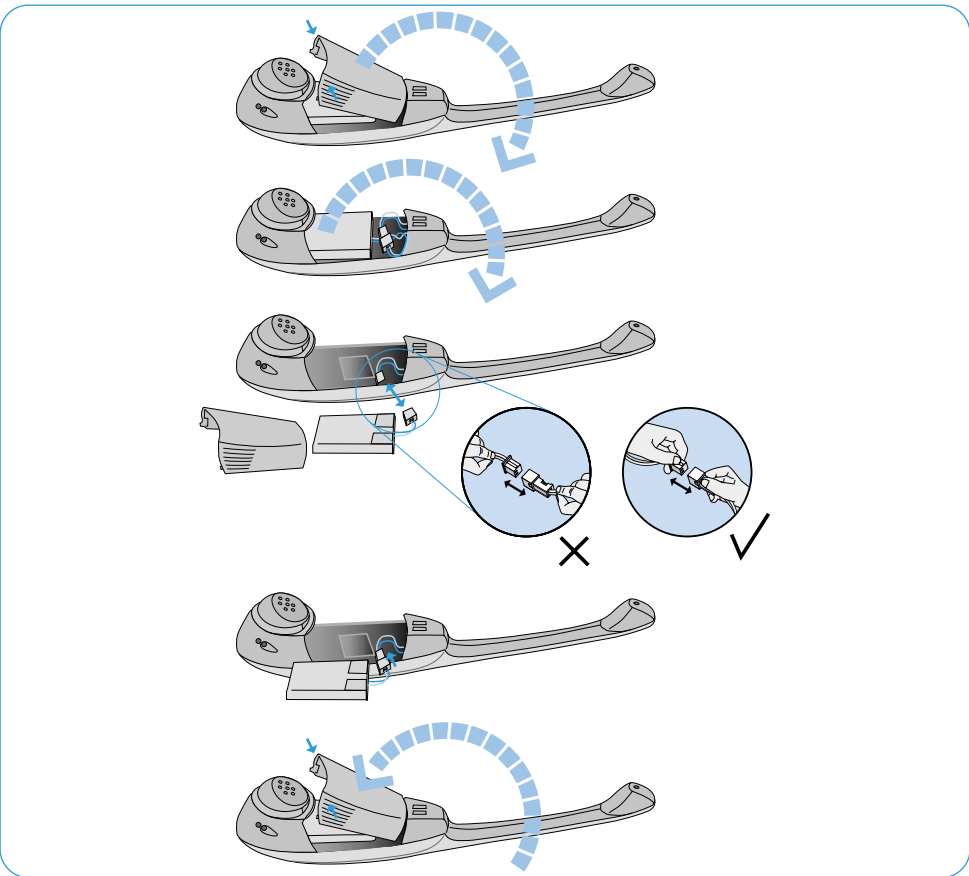

DIAGRAM KEY

BASE UNIT

- 1 Tx Slide Switch (A-D)
- 2 Rx Slide Switch (1-4)
- 3 Speak Volume Adjust UP
- 4 Speak Volume Adjust DOWN
- 5 IntelliStand™ Switch ON/OFF
- 6 Configuration Dial
- 7 AC Power Adapter
- 8 AC Power Adapter Port
- 9 Handset Cable Port
- 10 Telephone Cable Port
- 11 Accessory Port
- 12 Headset Docking Cradle
- 13 Charge contacts
- 14 Charge Indicator
- 15 Talk Indicator
- 16 Power Indicator
- 17 Handset Lifter (Optional)

HEADSET

- 18 Microphone
- 19 Speaker
- 20 Talk Button
- 21 Listen Volume Adjust UP/DOWN
- 22 Headset Mute Switch
- 23 On-line Indicator
- 24 Charge contacts
- 25 Battery Door

IMPORTANT SAFETY INFORMATION

Please read the following instructions before use:

General:

- Operating temperature +4C to +49C
- Storage temperature +4C to +49C
- The product is suitable for indoor use only
- To reduce the risk of electric shock, explosion or fire:
 - Use only the AC power adapter supplied – part number 61634-02 (Euro) or 61635-02 (UK)
 - Ensure that the voltage rating (e.g. 230V 50Hz) corresponds to the local mains supply you intend to use
 - Use only the correct battery type – part number – 62346-01
 - Do not disassemble the product
 - Keep all products, cords and cables away from operating machinery
 - Avoid contact with liquids
- Connect the base unit only to a host terminal port explicitly designated for use with handsets or headsets. Connection through other ports, such as data ports or line ports, may damage the product and could constitute a fire hazard. If in doubt, please contact your supplier or the supplier of the host equipment
- If mains power fails, the base unit will switch to handset mode

Battery Safety:

- Please observe these precautions to ensure continued safety. Misuse or mistreatment may result in fire, explosion or the release of corrosive chemicals
- Battery storage temperature +4C to +49C
- Battery operating temperature +4C to +49C

- Charge the headset battery as described in the Quickstart Guide and User Guide.
Do not charge with any other AC power adapter or charger
- Do not incinerate, disassemble, bend, crush or short-circuit the battery
- Dispose of spent battery promptly and safely in accordance with local regulations. Keep battery away from children
- Exercise care when handling the battery, AC power adapter, the base and the headset. Do not short the metal contacts (on the plastic casing) with electrically conducting materials such as rings, bracelets, keys etc
- If liquid from the battery comes in contact with the eyes, skin or any other part of the body, immediately flush with fresh water and seek medical advice
- For battery replacement please refer to the diagrams on page 3 or the Quickstart Guide supplied with the product

INSTALLATION

Please install the CS60 DECT™ Wireless Headset System in accordance with the instructions detailed in the Quick Start Guide.

HEADSET/HANDSET SELECTION

Pressing the Talk Button (20) on the Headset selects Headset mode. The Talk Indicator (15) on the base unit will illuminate and the On-Line Indicator (23) on the headset will flash when in Headset mode. Both of the indicators are extinguished when in Handset mode.

PLACING A CALL USING YOUR HEADSET

To place a call using the headset, the system must be in Headset mode. Take the handset off the hook and dial in the normal way. You will then be able to talk through your headset. When the call is complete, return the telephone handset to the cradle.

Tip: By selecting Handset mode after completing your call, you will conserve the headset battery power and extend the remaining available talktime. You can achieve this by pressing the Talk Button (20) immediately on conclusion of the call.

Note: If you have installed a Plantronics Handset Lifter (17) please refer to the section "Making a call using the Lifter" on page 7.

RECEIVING A CALL USING YOUR HEADSET

When your telephone rings take the handset off the hook. Ensure that your CS60 DECT™ Wireless Headset System is already in Headset mode. You will then be able to talk through your headset. When the call is complete, return the telephone handset to the cradle.

Note: If you have installed a Plantronics Handset Lifter (17) please refer to the section "Receiving a call using the lifter" on page 7.

PLACING AND RECEIVING A CALL USING THE HANDSET

In Handset mode the telephone can be used to make and receive calls in the normal way.

OUT OF RANGE WARNING

As you walk away from the base unit you will eventually reach the system operating range limit. When in Headset mode a warning alert of two beeps will sound in the headset shortly before you meet the range limit.

On hearing this alert you should walk closer to the base unit to ensure call quality is maintained. If you ignore this alert and walk out of range, a triple beep will sound in the headset and any active call will be suspended. On returning within range, a single beep will sound and the call will be re-established.

If you remain out of range for more than 15 minutes the system will drop the call permanently. If using a Plantronics Handset Lifter the handset will be replaced and the call terminated.

LOW BATTERY WARNING

When the headset battery is running low (approximately 5 minutes talk time remaining), an audible warning will be heard through the headset as a single beep repeating every 10 seconds. Soon after hearing this warning, you should recharge the headset.

RECHARGING THE HEADSET

To recharge the headset, place it into the Headset Docking Cradle (12) in the base unit. During charging, the Charge Indicator (14) on the base unit will flash.

When the headset is fully charged, the Charge Indicator (14) on the base unit will stop flashing and remain illuminated.

A completely depleted headset requires a minimum charge time of 1hr before it should be used and 3 hours to fully charge.

REPLACING THE HEADSET BATTERY

Should it be necessary to replace the headset battery at anytime please refer to the diagrams on page 3.

OPERATION WITH THE HANDSET LIFTER ACCESSORY

The Plantronics Handset Lifter (17) is an accessory that can be purchased for use with the CS60 DECT™ Wireless Headset System. It has two functions:

1. To automatically notify you when an incoming call is detected even when you are away from your desk.

2. To lift the telephone handset from its cradle at your command even when you are away from your desk.

The installation of the Handset Lifter (17) is described in the user guide that is supplied with it.

MAKING A CALL USING THE LIFTER

Press the Talk Button (20) on the headset. The lifter will raise the telephone handset off the hook. You will then hear a dial tone in your headset and can proceed to make a call as normal.

When you have finished your call press the Talk Button (20) on your headset. The handset lifter then lowers the handset to end the call.

RECEIVING A CALL USING THE LIFTER

When a new call is received the telephone rings as normal, but in addition, a ring alert comprising a repeating sequence of three short beeps will be heard in your headset.

Note: This additional call alert is only active when the Lifter (17) is connected.

To answer the call press the Talk Button (20) on the headset. The lifter will then raise the telephone handset off the hook and you will then be able to talk to the caller.

When you have finished your call press the Talk Button (20) on your headset. The handset lifter then lowers the handset to end the call.

IntelliStand™ FUNCTION

When the CS60 DECT™ Wireless Headset System is used in conjunction with a Plantronics Handset Lifter (17), you can enable the IntelliStand feature.

The IntelliStand senses when the headset has been removed or replaced in the CS60 Base Unit, automatically activating the lifter to answer or end a call.

The IntelliStand feature is disabled when the IntelliStand switch (5) is in position I or enabled when the switch is in position II.

SWITCHING FROM HEADSET TO HANDSET WHEN USING THE LIFTER

If during a call you are using your headset and want to switch to the telephone handset, remove the handset from the Lifter, then press the Talk Button (20) on your headset. The Lifter will lower and you will then be able to continue the call using the handset.

SWITCHING FROM HANDSET TO HEADSET WHEN USING THE LIFTER

If during a call you are using the telephone handset and want to switch to your headset, press the Talk Button (20) on the headset. The Lifter will raise and you will be able to continue the call using your headset.

Replace the telephone handset on the Lifter. When the call is finished press the Talk Button (20) on your headset. The Lifter will lower the handset and end the call.

PROBLEM

I plugged everything in but the lights won't come on.

Possible Cause	Solution
No power	<p>Check that the AC Power Adapter is connected to the base unit.</p> <p>Check that the AC Power Adapter is connected to the mains supply.</p> <p>Check that the AC Power Adapter is the model supplied by Plantronics.</p>

PROBLEM

I cannot hear caller / dial tone.

Possible Cause	Solution
CS60 DECT™ Wireless Headset System is not connected correctly	<p>Check that the telephone is connected to the base unit's Telephone Cable Port.</p> <p>Check that the handset is connected to the base unit's Handset Cable Port.</p>
Ensure you are in headset mode	Press the Talk Button to select correct mode.
Out of Range	Walk back into range.
Headset battery is flat	Recharge the battery by placing the headset in the Headset Docking Cradle.
Listen volume too low	<p>Adjust the Listen Volume Control on the headset.</p> <p>If the volume is still too low, select another Rx Slide Switch setting (refer to the Quickstart Guide).</p>
Incorrect Configuration Dial setting for your telephone	Try other Configuration Dial settings on the base unit.

PROBLEM

Callers cannot hear me.

<i>Possible Cause</i>	<i>Solution</i>
<i>Mute is selected</i>	<i>Press the mute button once. The audible mute indicator should then stop beeping.</i>
<i>Headset microphone boom is incorrectly positioned</i>	<i>Align the headset boom with your mouth</i>
<i>Speak volume is too low</i>	<i>Increase the Speak Volume by adjusting the Speak Volume Controls on the base unit. If the volume is still too low, select another Tx Slide Switch setting (refer to the Quickstart Guide).</i>
<i>Incorrect Configuration Dial setting for your telephone</i>	<i>Try other Configuration Dial settings on the base unit.</i>

PROBLEM

I can hear a dial tone in more than one configuration position

<i>Possible Cause</i>	<i>Solution</i>
<i>Telephone will work in more than one Configuration Dial position</i>	<i>Use the position that sounds best to you and the person you call.</i>

PROBLEM

I tried all four positions on the Configuration Dial and cannot hear a dial tone in any position.

<i>Possible Cause</i>	<i>Solution</i>
<i>CS60 DECT™ Wireless Headset System is not connected correctly</i>	<i>Check that the telephone is connected to the base unit's Telephone Cable Port. Check that the handset is connected to the base unit's Handset Cable Port.</i>
<i>You may have an incompatible phone</i>	<i>Call your supplier or local Plantronics office for help.</i>
<i>The telephone line is dead</i>	<i>Reconnect the handset to the telephone and test.</i>

PROBLEM

Receive sounds distorted.

Possible Cause	Solution
Listen volume too high on your telephone	<p>If your telephone has a receive volume control, lower this until the distortion disappears.</p> <p>If the distortion is still present, lower the listen volume control on the headset. If the distortion persists, select another Rx Slide Switch setting. (Refer to the Quickstart Guide).</p>

PROBLEM

I can hear too much background conversation, noise or sidetone.

Possible Cause	Solution
Speak volume is too high	<p>Lower the Speak Volume by adjusting the Speak Volume control on the base unit.</p> <p>If the volume is still too high, select another Tx Slide Switch Setting (refer to the Quickstart Guide)</p>

PROBLEM

Sudden loss of audio, continuous noise or distorted audio on receive.

Possible Cause	Solution
Software reset required	<p>Press the Talk button (20) twice.</p> <p>If the problem persists perform a System Reset refer to instructions on page 11.</p>

PROBLEM

My handset Lifter operates every time I remove or replace my headset in the base unit.

Possible Cause	Solution
IntelliStand™ function is enabled.	To disable the IntelliStand function move the IntelliStand Switch to position 1 (Off).

PROBLEM

Battery talktime performance is significantly degraded even after a full recharge.

Possible Cause	Solution
Battery approaching end of life	Replace with a new battery pack. Refer to the diagrams on page 3.

SUBSCRIPTION

The Headset and Base Unit are supplied subscribed to each other. However if you wish to use a replacement headset with the base unit then the units must be re-subscribed as follows:

1. Return the headset to the Headset Docking Cradle (12).
2. Press and hold both the Speak Volume Adjust Buttons (3 & 4) on the base unit for a minimum of 5 seconds. The Power Indicator (16) will then flash.
3. Press and hold the Headset Mute Switch (22) for a minimum of 5 seconds. The On-line Indicator (23) will then illuminate.
4. Subscription completion is indicated when the Power Indicator (16) is fully illuminated and the On-line Indicator (23) is extinguished.
5. If subscription fails within 2 minutes the headset will return to the un-subscribed state.

SYSTEM RESET

To recover from some fault conditions (refer to the Troubleshooting section) you may need to perform a system reset.

To reset the headset press both the Talk button (20) and Mute button (22) for 5 seconds. When the On Line Indicator (23) blinks, release both buttons. Press the Talk button (20) again. Next reset the base unit by disconnecting the AC power adapter (7) from the AC Power Adapter Port (8) for 5 seconds, then reconnect. The system reset operation is then complete.

MAINTENANCE HINTS

1. Unplug the unit from the telephone and the AC Power Adapter from the mains supply before cleaning.
2. To clean the headset, remove the headset from the attachment and wipe clean.
3. Clean the equipment with a damp (not wet) cloth.
4. Do not use solvents or other cleaning agents.

OPTIONAL PARTS & ACCESSORIES

There are a range of Plantronics accessories designed to enhance the functionality of your CS60 DECT™ Wireless Headset System. Please contact your Plantronics Supplier for further details.

1. HL10 Telephone Handset Lifter
2. On-Line Indicator
3. On-Line Indicator Extension Cable
4. Accessory Converter Cable
5. Battery
6. Battery Door
7. AC Power Adapter (UK only)
8. AC Power Adapter (Europe excluding UK)
9. Base Unit Cable
10. CS60 Headset
11. Earloops (pack of 3)
12. Behind-the-Head Neckband
13. Over-the-Head Band

WARRANTY AND SERVICE

- Plantronics guarantees the satisfactory condition of the equipment with regard to manufacturing and material defects for 2 years from the date of purchase. (Please retain the original receipt).
- This product should be installed and used in accordance with the instructions detailed in this user guide, and serviced at an approved Plantronics Service Centre. Failure to comply with these conditions may render the warranty void.
- This does not affect your statutory rights.

Plantronics 2 year Warranty and Repair Service



Plantronics 2 year Warranty and Repair Service

- UK** • Products under warranty are replaced free of charge.
• All units serviced to full production standards using original factory parts.
0800 410014
- D** • Produkte werden innerhalb der Garantiezeit kostenfrei repariert oder ersetzt.
• Der Service erfolgt gemäß den Produktionsstandards unter Verwendung von Originalteilen.
02222/8302-134
- DK** • Produkter dækket af garanti vil blive ombyttet uden beregning.
• Alle enheder efterses i henhold til produktionsstandarder og ved brug af originale fabriksdele.
+45 44 35 05 35
- E** • Los productos en periodo de garantía serán reparados libre de cargos.
• Todas las unidades preparadas según estándares de funcionamiento a pleno rendimiento con piezas originales de fábrica.
902 415191
- F** • Les produits sous garantie sont remplacés gratuitement.
• Les réparations répondent aux normes de production et sont réalisées avec des pièces d'origine.
0825 0825 99
0,15 € TTC / mn
- I** • I prodotti in garanzia verranno sostituiti gratuitamente.
• L'assistenza di tutte le unità viene effettuata in conformità con gli standard di produzione utilizzando parti di ricambio originali.
02 9511900
- N** • Produktet erstattes gratis i garantiperioden.
• Alt utstyr er overhaldt med originaldeler og holder produktionsstandard.
+47 23 17 37 70
- NL** • Producten die onder de garantie vallen, worden kosteloos vervangen.
• Alle units voldoen volledig aan de productie-eisen en zijn vervaardigd van originele fabrieksonderdelen.
0800 7526876 (NL)
00800 75268766 (BE/LUX)
- P** • Os produtos cobertos pela garantia são substituídos gratuitamente.
• Todas as unidades recebem assistência técnica em conformidade com os padrões de produção utilizando peças de fábrica originais.
+34 91 6404744
- SF** • Takuunalaiset vikaantuneet tuotteet vaihdetaan.
• Kaikki yksiköt huolletaan täysin tuotantovaatimusten mukaan. Varaosina käytetään vain alkuperäisiä osia.
+358 9 88 16 85 20
- S** • Produkter med gällande garanti byts ut utan kostnad.
• Alla enheter uppfyller produktionsstandarden och består av originaldelar.
Megalans:
+46 31 55 88 00
Anovo:
+46 26 17 30 40

Plantronics Ltd

Wootton Bassett, UK
Tel: 0800 410014
+44 (0)1793 842200

Plantronics B.V.

Hoofddorp, Nederland
Tel: (0)0800 PLANTRONICS
0800 7526876 (NL)
00800 75268766 (BE/LUX)

Plantronics Sarl

Noisy-le-Grand, France
No Indigo: 0825 0825 39
0,15 € TTC / mn
+33 (0)1 41 67 41 41

Plantronics GmbH

Hürth, Deutschland
Tel: 0800 9323400
+49 22 33 3990
Österreich: 0800 242 500
Schweiz: 0800 932 340

**Plantronics Acoustics
Italia Srl**

Milano, Italia
Numero Verde: 800 950934
+39 02951 1900

Plantronics Iberia, S.L.

Madrid, España
Tel: 902 41 51 91
+34 91 640 47 44

Nordic Region

Tel: Finland: 0201 550 550
Tel: Sverige: 031 28 95 00
Tel: Danmark: 44 35 05 35
Tel: Norge: 23 17 37 70

**Plantronics Middle East,
Eastern Europe, Africa
and India**

Tel: +44 (0)1793 842443

Plantronics Ltd, Interface Business Park, Bincknoll Lane,
Wootton Bassett, Wiltshire SN4 8QQ. ENGLAND

www.plantronics.com



PLANTRONICS®

World Leader in Communications Headsets



36685-00 Rev A